

RS485

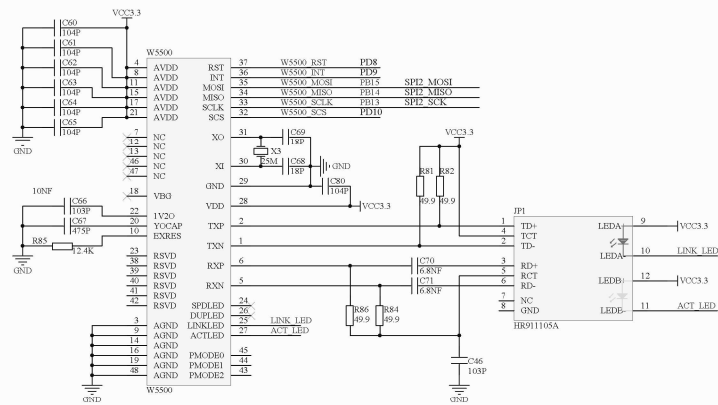

CAN&USB

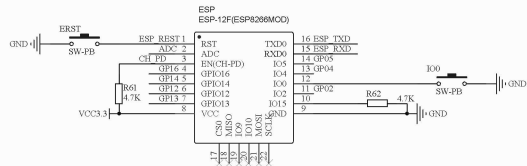
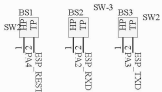
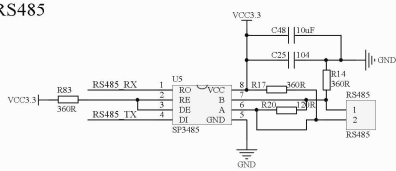
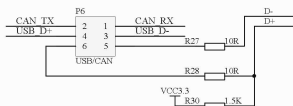
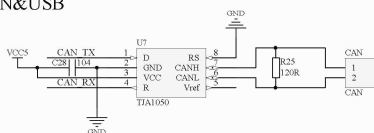

SD CARD&INTERNET

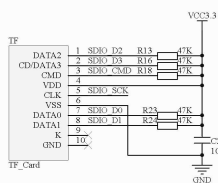

FLASH

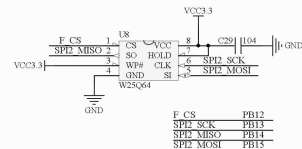

LED

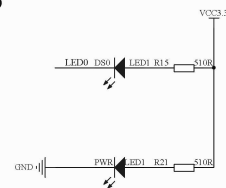

EEPROM

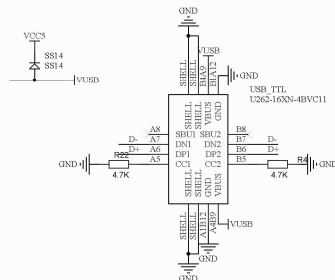
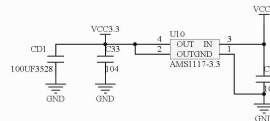
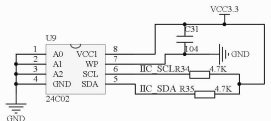

Title		Revision
Size	Number	
A2		
Date	2023/11/18	Sheet of
File	D:\Bash\Bash\Download\FXCT_SPC_Sch\	Drawn By: